



Model 4600



precisely.

**OWNER & OPERATOR
INSTRUCTION MANUAL**

Model # _____

Serial # _____



FOR GLOBE SLICER MODELS 4600, 4850, 4975

For Service on your Slicer

1. Check the enclosed authorized servicer list for the servicer nearest you
2. Or...Visit our website at www.globeslicers.com (select Service button)
3. Or...Call Globe service department 937-297-7247 and ask for the contact information for your local service company.

- IMPORTANT SAFETY NOTICE -

This manual contains important safety instructions which must be strictly followed when using this equipment.

INDEX

ATTENTION OWNERS AND OPERATORS	4
KEY COMPONENTS OF THE SLICER	5
GLOBE SLICER SAFETY TIPS	6
INSTALLATION AND PROPER GROUNDING	7-8
OPERATING INSTRUCTIONS	9-10
AUTOMATIC OPERATING INSTRUCTIONS	11-12
CLEANING	13-15
KNIFE SHARPENING	16-17
SIMPLE MAINTENANCE AND REPAIR	18-19
OPTIONAL ACCESSORIES	20-21
OPTIMAL SLICING PERFORMANCE	22
SERVICE AND TROUBLESHOOTING	23
LIMITED WARRANTY	24



GLOBE FOOD EQUIPMENT COMPANY
P.O. BOX 3209
DAYTON, OH 45401
PHONE: 937-299-5493
FAX: 937-299-4147
E-MAIL: globeinfo@globeslicers.com
WEBSITE: www.globeslicers.com

ATTENTION OWNERS AND OPERATORS

Globe's equipment is designed to provide safe and productive processing of food products as long as the equipment is used in accordance with the instructions in this manual and is properly maintained. Importantly, unless the operator is adequately trained and supervised there is a possibility of serious injury. Owners of this equipment bear the responsibility to make certain that this equipment is used properly and safely. Strictly following all the instructions contained in this manual and the requirements of local, state or federal law.

Owners should not permit anyone to touch this equipment unless they are over 18 years old, are adequately trained and supervised, and have read and understood this manual. Owners should also ensure that no customers, visitors or other unauthorized personnel come in contact with this equipment. Please remember that Globe cannot anticipate every circumstance or environment in which its equipment will be operated. It is the responsibility of the owner and the operator to remain alert to any hazards posed by the function of this equipment -- particularly the sharp knife blade and all moving parts. If you are ever uncertain about a particular task or the proper method of operating this equipment, ask your supervisor.

This manual contains a safety tips section listing a number of precautions to follow to help promote safe use of this equipment. Throughout the manual you will see additional warnings to help alert you to potential hazards.

Warnings affecting your personal safety are indicated by:



Warnings related to possible damage to the equipment are indicated by:



A wall chart, with safety instructions is included with this equipment. This wall chart should be posted near the slicer within easy view of the operator. You should make certain that this manual is available for easy reference by any operator. Globe has put several warning labels in the English language on its slicers. Spanish labels are packed in the shipping carton and can replace the English labels at the owner's discretion. If the warning labels, the wall chart, or this manual are misplaced, damaged, or illegible, or if you require additional copies, please contact your nearest representative or Globe directly for these items at no charge.

Please remember that this manual, the wall chart, and the warning labels do not replace the need to be alert, properly train and supervise operators, and use common sense when using this equipment.

KEY COMPONENTS OF THE SLICER

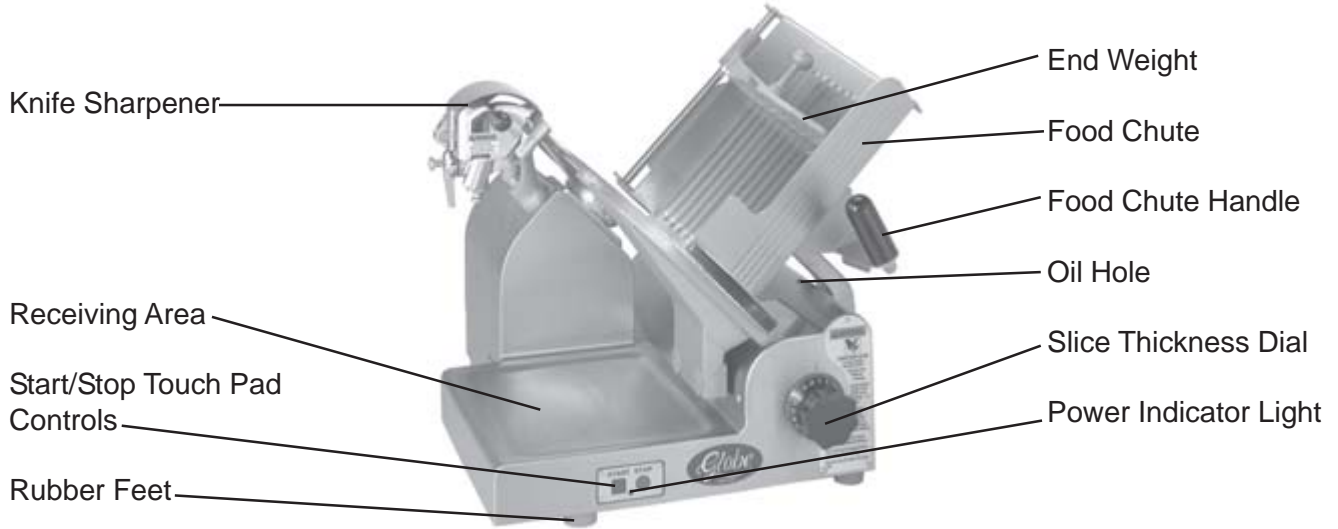

4600 FRONT VIEW

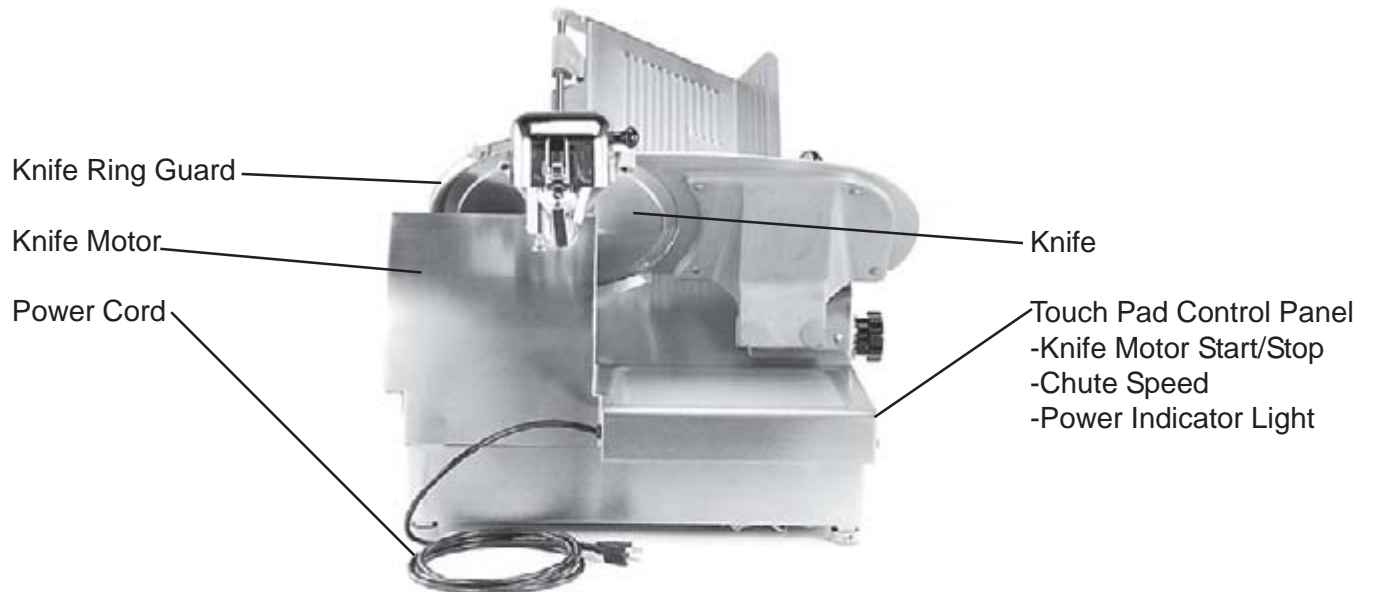

4975 LEFT SIDE VIEW

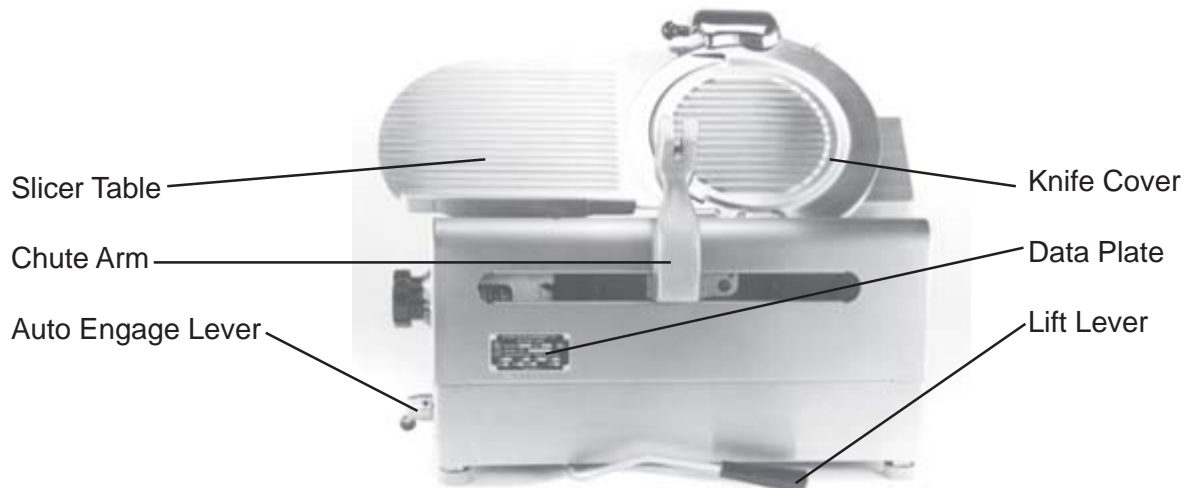

4975 RIGHT SIDE VIEW

WARNING



SHARP KNIFE BLADE

TO AVOID SERIOUS PERSONAL INJURY:

- **NEVER** touch this slicer without training and authorization from your supervisor or if you are under 18 years old. Read owners and operator manual first.
- **ONLY** install on level nonskid surface in clean, well-lighted work area away from children and visitors.
- **ALWAYS** ground slicer utilizing proper power source.
- **NEVER TOUCH KNIFE.** Keep hands and arms away from all moving parts.
- **NEVER OPERATE** slicer without knife cover and knife ring guard securely installed.
- **BEFORE TURNING SLICER ON,** place auto engage lever in "Manual" position (automatic slicers only).
- **ONLY USE FOOD CHUTE HANDLE** to push the food chute during manual slicing.
- **ONLY USE THE END WEIGHT, NOT YOUR HAND,** to hold food products when slicing. Never put your hand on or around food chute when slicer is on.
- **ALWAYS** turn off slicer, return auto engage lever to "Manual" position (automatic slicers only), and turn slice thickness dial completely clockwise after each use.
- **BEFORE CLEANING, SHARPENING, SERVICING, OR REMOVING ANY PARTS,** always turn slicer off, turn slice thickness dial clockwise to closed position, remove food chute, and unplug power cord.
- **USE ONLY GLOBE SLICER ACCESSORIES** properly installed.

INSTALLATION

UNPACKING:

1. Unpack the slicer immediately after receipt. If the machine is found to be damaged, save the packaging material and contact the carrier within fifteen (15) days of delivery. Immediately contact your source of the equipment. You have no recourse to damage after fifteen (15) days.
2. You should receive with the slicer, rubber feet, Globe oil, warranty card, wall chart and an owners operator instruction manual. Contact Globe or your local supplier if you did not receive all of these materials.



TO AVOID SERIOUS PERSONAL INJURY PROPERLY INSTALL SLICER IN ADEQUATE WORK AREA

- **ALWAYS** install equipment in work area with adequate light and space.
- **ONLY** operate on a solid, level, nonskid surface.
- **NEVER** bypass, alter, or modify this equipment in any way from its original condition. Doing so may create hazards and will void warranty.
- **NEVER** operate slicer without knife cover and knife ring guard securely installed.
- **NEVER** operate without all warnings attached and Globe warning card and wall chart posted.

INSTALLATION:

1. Read this manual thoroughly before installation and operation. **DO NOT** proceed with installation and operation if you have any questions or do not understand anything in the manual. Contact your local representative or Globe **first**.
2. Remove the slicer from the corrugated box.
3. Attach rubber feet to slicer base, making sure they are firmly tightened.



NEVER USE SLICER WITHOUT RUBBER FEET INSTALLED.

4. Select location for slicer that has a level, solid, nonskid surface and a well-lighted work area away from children and visitors.



**USE AT LEAST TWO PEOPLE TO LIFT SLICER UP TO OPERATING LOCATION.
NEVER ATTEMPT TO LIFT SLICER ALONE.**

INSTALLATION AND PROPER GROUNDING

⚠ THIS MACHINE IS PROVIDED WITH A THREE-PRONG GROUNDING PLUG. THE OUTLET TO WHICH THIS PLUG IS CONNECTED MUST BE PROPERLY GROUNDED. IF THE RECEPTACLE IS NOT THE PROPER GROUNDING TYPE, CONTACT AN ELECTRICIAN. DO NOT UNDER ANY CIRCUMSTANCES CUT OR REMOVE THE THIRD GROUND PRONG FROM THE POWER CORD OR USE ANY ADAPTER PLUG (Fig. 8-1 and Fig. 8-2).

5. Post Globe safety tips and wall chart in a location within easy view of operator.
6. Inspect slicer to ensure all parts have been provided.
7. Make sure knife cover, knife ring guard and knife sharpener cover are in place.
8. Make sure warning labels are properly positioned and legible and owners manual is available near slicer. Place the Spanish labels on the slicer if your work force requires them.
9. Complete warranty card and mail to Globe factory.
10. Clean the slicer using the procedures outlined in the cleaning section (pages 13 through 15) prior to using the slicer.
11. Contact your local representative or Globe directly if you have any questions or problems with the installation or operation of this slicer.



Figure 8-1 Correct



Figure 8-2 Incorrect

OPERATING INSTRUCTIONS

▲ WARNING



SHARP KNIFE BLADE

TO AVOID SERIOUS PERSONAL INJURY:

- **NEVER** touch this slicer without training and authorization from your supervisor or if you are under 18 years old. Read owners and operator manual first.
- **NEVER TOUCH KNIFE.** Keep hands and arms away from all moving parts.
- **NEVER OPERATE** slicer without knife cover and knife ring guard securely installed.
- **BEFORE TURNING SLICER ON,** place auto engage lever in "Manual" position (automatic slicers only).
- **ONLY USE FOOD CHUTE HANDLE** to push the food chute during manual slicing.
- **BE ALERT** that the food chute moves back and forth during automatic operation and can move in either direction on start up.
- **ONLY USE THE END WEIGHT, NOT YOUR HAND,** to hold food products when slicing. Never put your hand on or around food chute when slicer is on.
- **ALWAYS** turn off slicer, return auto engage lever to "Manual" position (automatic slicers only), and turn slice thickness dial completely clockwise after each use.
- **BEFORE CLEANING, SHARPENING, SERVICING, OR REMOVING ANY PARTS,** always turn slicer off, turn slice thickness dial clockwise to closed position, remove food chute, and unplug power cord.

OPERATING INSTRUCTIONS

MANUAL SLICER OPERATION

1. With slicer off, pull the food chute completely towards you and place the food product on the food chute. Slice only boneless, unfrozen product with the slicer. Use the end weight to hold the food product in place. If the end weight is not needed, it may be stored out of the way by swinging it back behind the food chute and locking it on the retaining pin.
2. Make sure all knobs are tightened prior to using the slicer.
3. Rotate slice thickness dial counterclockwise to desired slice thickness. After slicing is complete, always turn slice thickness dial completely clockwise to close slicer table.
4. Turn slicer on by pressing the start button. The power indicator light will illuminate.

NOTE: If the slicer does not start and the indicator light is flashing the food chute is not in the home position. Pull the food chute all the way forward and restart the slicer.



DO NOT hold the food product with your hand. Never put your hand on or around food chute when slicer is on. The food chute handle is the only part of the slicer you should touch while slicing.

5. Use the food chute handle to manually push the food chute back and forth. The food chute handle is the only part of the slicer you should touch while slicing.



If a product needs to be adjusted during slicing, ALWAYS pull the food chute all the way towards you. Turn off slicer, and close slicer table prior to adjusting the product and the end weight.

6. After the last slice stroke, pull the food chute all the way towards you. Turn the slicer off by pressing the stop button. The power indicator light will go out. Always turn slice thickness dial completely clockwise to close the slicer table.
7. Now you can load and unload food product from the food chute.

NOTE: The slicer is equipped with an auto-off timer. After 10 seconds of no chute movement the slicer will shut off. Also, the slicer will not start unless the food chute is pulled all the way forward.

AUTOMATIC OPERATING INSTRUCTIONS

WARNING



MANUAL USE OF AUTOMATIC SLICER

! ALWAYS make sure the auto engage lever is in the “Manual” position before turning slicer on (Fig. 11-1).

1. Automatic slicers can be used manually when desired.
2. When manually operating an automatic slicer the auto engage lever **MUST** be in the “Manual” position before turning the slicer on. The lever should not be moved out of the “Manual” position at any time during use.
3. Turn the slicer on by pressing the start button.



Figure 11-1

Auto Engage Lever

NOTE: If the slicer does not start and there is a flashing 1 the auto engage lever is not in the manual position. Put the lever in the manual position and restart the slicer.

NOTE: If the slicer does not start and there is a flashing 4 the food chute is not in the home position. Pull the food chute all the way forward and restart the slicer.

AUTOMATIC SLICER OPERATION

! BEFORE beginning to use the slicer for automatic slicing, MAKE SURE the auto engage lever is in the “Manual” position.

! Automatic slicer operation: NEVER put hand into chute arm opening on right side of slicer. Keep hands and arms away from all moving parts.

1. Make sure the slicer is turned off (power indicator light not illuminated). Make sure the auto engage lever is in “Manual” position and that the food chute moves freely.
2. Pull the food chute completely towards you and load the food product. Swing the end weight into position to secure food product.
3. If the food product is too long, place the end weight on top of the food product and use the end weight prongs to hold the food product in place.
4. Auto engage lever must be in “Manual” position to start the slicer.

NOTE: The slicer will not start unless the food chute is all the way forward.

AUTOMATIC OPERATING INSTRUCTIONS

5. Press the start button. The power indicator light will illuminate.

NOTE: If the slicer does not start and there is a flashing 1 the auto engage lever is not in the manual position. Put the lever in the manual position and restart the slicer.

NOTE: If the slicer does not start and there is a flashing 4 the food chute is not in the home position. Pull the food chute all the way forward and restart the slicer.

⚠ BE ALERT. The next step will cause the food chute to move automatically and it can move either direction on start up.

⚠ NEVER attempt to adjust, load or unload food chute when slicer is in automatic operation.

NOTE: Chute speed can be adjusted prior to or after auto engagement.

6. To make the food chute move automatically, pull or raise the auto engage lever into the “Automatic” position (Fig. 12-1).
 - a. Model 4850 – To adjust the chute speed press the faster button for 60 strokes per minute and the slower button for 40 strokes per minute.
 - b. Model 4975 – To adjust the chute speed press the slower or faster buttons. The slicer defaults to speed 5 when the power cord is unplugged and plugged back in. If the slicer is turned off but not unplugged, it will return to the last speed used.



Figure 12-1
Auto Engage Lever

NOTE: The automatic slicers are equipped with a PAUSE feature that can be used when product needs to be switched during slicing. To activate the PAUSE feature press the start button while the slicer is in automatic operation. The food chute will return to the home position and a P will be flashing. After the product is placed on the food chute press the start button to reactivate the slicer. If the start button is not pressed the slicer will shut off after a certain amount of time.

7. To stop the automatic movement of the food chute, push down or lower the auto engage lever to the “Manual” position.

⚠ The knife is still rotating even though the chute has stopped.

8. To turn slicer completely off and stop the knife, press the stop button. If the auto engage lever has not already been returned to the “Manual” position, push down or lower the lever to the “Manual” position.
9. Using the food chute handle, pull the food chute all the way towards you. Turn slice thickness dial completely clockwise to close the slicer table. Now you can load and unload food product from the food chute.
10. When finished using slicer, make sure slicer is turned off, the slice thickness dial is turned completely clockwise, and the auto engage lever is in the “Manual” position.

CLEANING

⚠ WARNING



SHARP KNIFE BLADE

TO AVOID SERIOUS PERSONAL INJURY:

- **BEFORE CLEANING, SHARPENING, SERVICING, OR REMOVING ANY PARTS**, always turn slicer off, turn slice thickness dial clockwise to closed position, remove food chute, and unplug power cord.
- **NEVER** attempt to clean slicer with the knife running.
- **NEVER** attempt to remove knife or knife ring guard for cleaning.

Your slicer should be cleaned and sanitized as often as necessary or at least once per day. Slicer components are easily disassembled without the use of special tools.

NOTE: It may be desirable to wear non-cutting safety gloves during the cleaning operation.

DISASSEMBLY & CLEANING

1. Turn slicer off.
2. Turn slice thickness dial completely clockwise so table covers knife edge.
3. Remove the food chute by loosening the food chute release knob that fastens the food chute to the chute arm. Lift the food chute off the chute arm. The chute cannot be removed without first closing the slice thickness dial.
4. Unplug power cord.

Spring Loaded Knob



Figure 13-1



BE ALERT. The next steps will expose the knife.

5. Lift knife sharpener cover.
6. While holding the knobs on the knife cover, pull up on the top spring loaded knob (Fig. 13-1) and lift upward to remove (Fig. 13-2). Slicer will not start with knife cover removed.



NEVER attempt to remove or dismantle the knife ring guard.



NEVER try to remove the knife from the slicer. It must remain on the slicer for proper operation, sharpening, and cleaning.



Figure 13-2

CLEANING

⚠ CAUTION

- **DO NOT** put components in dishwasher.
- Dilute detergent per supplier's instruction.
- **DO NOT** hose down, pressure wash, or pour water on the slicer.
- **NEVER** use scrubber pad, steel wool, or abrasive material to clean the slicer.
- **NEVER** remove sharpener from slicer or immerse in water.
- Clean the disassembled components with a mild detergent and warm water solution. Allow parts to air dry.
- **DO NOT** use bleach or other caustic/strong detergents on the slicer base or components.
- Dilute detergent per supplier's instruction. Products containing sodium hypochlorite should not be used on the slicer.

⚠ **NEVER try to clean, sharpen, or operate slicer with the lift lever in the raised position (automatic slicers only).**

⚠ **ALWAYS turn off slicer and unplug power cord BEFORE cleaning.**

7. To clean the knife ring guard, soak a clean cloth in a mild detergent and warm water solution. Ring out excess water from cloth. **Carefully** insert the cloth between the knife and the knife ring guard (Fig. 14-1). While holding the cloth between the knife and the knife ring guard, work it along the entire backside of the knife. Repeat this procedure as necessary. A nylon brush could also be used if preferred.



Figure 14-1

8. The knife must also be cleaned. **Carefully** wash and rinse the top and bottom of the knife by wiping from the **center of the knife outward** (Fig. 14-2).



Figure 14-2

⚠ **CAUTION** **DO NOT allow moisture to get into knife hub.**

9. After cleaning and drying knife cover, replace it by aligning the notches at the bottom of the knife cover with the knobs located at the bottom of the knife ring guard (Fig. 14-3). The top right of the knife cover also has a hole that fits over a locator pin at the top of the knife ring guard. **NOTE:** The slicer will not operate unless the knife cover is in place and secure.



Figure 14-3

10. Lower the knife sharpener cover.

11. Soak a clean cloth in a mild detergent and warm water solution. Ring out excess water from cloth. With the slicer table completely closed, wipe the slicer table off by starting at the knife and pulling towards you. Never wipe the slicer table towards the knife.

CLEANING

12. Clean and wipe down the entire slicer. Use a mild non-bleach, non-chlorine sanitizer if required.



DO NOT use caustic or strong detergents on the slicer base or components.

REASSEMBLY

1. Manual slicers are equipped with a cleaning brace that raises the slicer to allow cleaning underneath. Push the chute arm to the back of the slicer. Simply lift up the front of the slicer and pull the brace completely towards the front of the slicer and lower the unit (Fig. 15-1).
2. Automatic slicers have a lift lever that raises the slicer to allow cleaning underneath.
 - a. With the auto engage lever in “Manual” position, push the chute arm to the back of the slicer.
 - b. Pull the lift lever knob towards you with your right hand while gently lifting up on the slice thickness dial with the other (Fig. 15-2).
 - c. Pull the lift lever all the way towards you until it stops (Fig. 15-3).
3. After cleaning the counter area under the slicer, lower slicer back to its operating position.
4. Install food chute to the original position on the chute arm. Tighten food chute release knob securely to prevent any “play” between the food chute and chute arm.



Figure 15-1



Figure 15-2



Figure 15-3

KNIFE SHARPENING

⚠ WARNING



SHARP KNIFE BLADE

TO AVOID SERIOUS PERSONAL INJURY:

- **NEVER** touch rotating knife.
- **ALWAYS** keep hands clear of all moving parts.
- **ALWAYS** turn off slicer, return auto engage lever to “Manual” position (automatic slicers only), turn slice thickness dial completely clockwise, and remove food chute before sharpening.
- **NEVER** sharpen slicer unless all guards are installed.
- **ALWAYS** make sure food chute is removed and auto engage lever is in “Manual” position when sharpening automatic slicers.

GENERAL

1. Symptoms of a dull knife are excess waste/or a “tail” on the unsliced portion remaining in the food chute.
2. The knife needs to be sharpened periodically to provide consistent slices and maximum food product yield. Sharpening the knife lightly every few days is more efficient than heavy sharpening at less frequent intervals.

PREPARING TO SHARPEN



Turn slicer off by pressing the stop button .



Make sure auto engage lever is in the “Manual” position (automatic slicers only).

1. Turn slice thickness dial completely clockwise so the slicer table covers knife edge.
2. Remove food chute from slicer.
3. Clean and dry both sides of the knife before sharpening, following instructions for knife cleaning on pages 13 and 14.

KNIFE SHARPENING

⚠ BE ALERT. The next steps will expose the knife.

4. Lift the sharpener cover to expose sharpening stones (Fig. 17-1). Stones should be clean and dry.

⚠ ALWAYS keep hands and arms away from exposed knife.



Figure 17-1

SHARPENING THE KNIFE

1. Pull on knob #1 (Fig. 17-2) keeping it extended and swinging sharpener up into position. Release knob, and sharpener will lock in sharpening position.

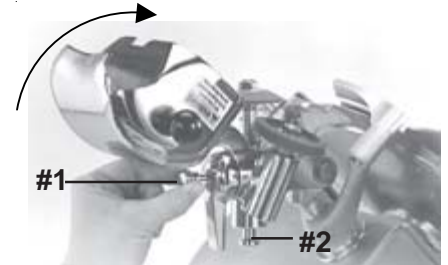

Figure 17-2

2. Pull out knob #2 (Fig. 17-3).

3. Turn knife motor on by pressing the start button. Pull the lever counterclockwise to bring stones into contact with the knife (Fig. 17-4). Maintain pressure on the lever for 10 seconds. Be sure both stones are in contact with knife. Repeat operation until knife is sharp.

NOTE: If knife becomes very dull, activate only the bottom stone by pushing in knob #2. When sharpening with the bottom stone is complete a slight burr will be raised on top of the knife. Pull out knob #2 and sharpen for 10 seconds with both stones contacting the blade.

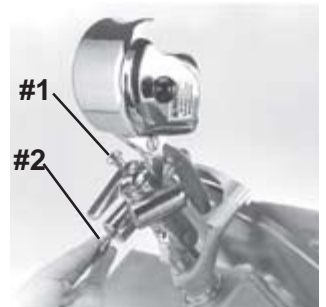

Figure 17-3

⚠ TURN OFF slicer before inspecting.

FINISH SHARPENING

When sharpening is finished, follow these procedures:

1. Turn the slicer off by pressing the stop button. Unplug the power cord.
2. Return the sharpener to its original position by pulling on knob #1 keeping it extended and swinging sharpener back to stored position.
3. If sharpening stones need to be cleaned, use soapy water and a brush. Dry stones afterwards.
4. Close sharpener cover.
5. Clean slicer as necessary using cleaning procedures listed on pages 13 through 15.
6. Plug in power cord.
7. Reinstall food chute on slicer.



Figure 17-4

SIMPLE MAINTENANCE AND REPAIR

⚠ WARNING



SHARP KNIFE BLADE

TO AVOID SERIOUS PERSONAL INJURY:

- **BEFORE CLEANING, SHARPENING, SERVICING, OR REMOVING ANY PARTS**, always turn slicer off, turn slice thickness dial clockwise to closed position, remove food chute, and unplug power cord.
- **NEVER** touch this slicer without training and authorization from your supervisor or if you are under 18 years old. Read owners and operator manual first.
- **NEVER TOUCH KNIFE.** Keep hands and arms away from all moving parts.
- **DO NOT** tamper with, bypass, or remove any safety devices, guards, on/off tab, or touch pad controls.
- **ALWAYS** turn off slicer, return auto engage lever to “Manual” position (automatic slicers only), and turn slice thickness dial completely clockwise after each use.
- **USE ONLY GLOBE PARTS AND ACCESSORIES** properly installed.

LUBRICATION

Various slicer parts need to be lubricated periodically using Globe oil. Globe oil is a light, tasteless odorless mineral oil that will not contaminate or impart odors or taste to sliced food product.

⚠ CAUTION

DO NOT USE VEGETABLE OIL TO LUBRICATE SLICER. VEGETABLE OIL WILL DAMAGE THE SLICER.

Chute Slide Rods

It is necessary to lubricate the food chute slide rods with Globe oil weekly or when excessive drag is felt.

1. Close slicer table.
2. Pull food chute handle completely forward (towards you). Remove the food chute to improve the access to the oil hole. **NOTE:** It is important that the food chute arm is as close as possible towards you for oil reservoir to be located under oil hole.
3. Remove cap from oil container. Add several drops of Globe oil into the oil hole (Fig. 18-1).
4. Wipe off excess oil.



Figure 18-1

SIMPLE MAINTENANCE AND REPAIR

End Weight Slide Rod

1. Add a few drops of Globe oil to the end weight rod daily (Fig. 19-1). Move the end weight up and down several times to distribute the oil.

Slide Rod

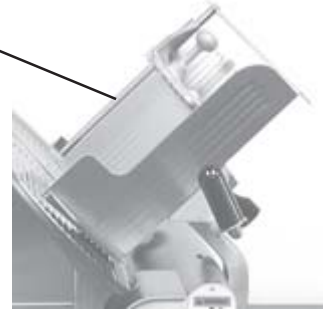

Figure 19-1

Sharpener

1. The sharpener shafts should be lubricated every couple of days with a few drops of Globe oil. Add Globe oil to each of the sharpener shafts as designated by the arrows (Fig. 19-2 and Fig. 19-3).

Other Lubrication

It is recommended that all threaded screws be lubricated after each cleaning to maximize the life of your slicer.

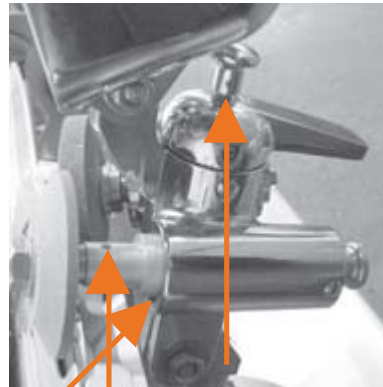

Figure 19-2



Figure 19-3

OPTIONAL ACCESSORIES

⚠ WARNING



SHARP KNIFE

TO AVOID SERIOUS PERSONAL INJURY:

- **ALWAYS** turn off slicer, return auto engage lever to “Manual” position (automatic slicers only), turn slice thickness dial clockwise to closed position, remove food chute, and unplug power cord **BEFORE** installing accessories.
- **NEVER TOUCH KNIFE.** Keep hands and arms away from all moving parts.
- **NEVER OPERATE** slicer without knife cover and knife ring guard securely installed.
- **BEFORE TURNING SLICER ON**, place auto engage lever in “Manual” position (automatic slicers only).
- **ONLY USE FOOD CHUTE HANDLE** to push the food chute during manual slicing.
- **ONLY USE THE END WEIGHT, NOT YOUR HAND**, to hold food products when slicing. Never put your hand on or around food chute when slicer is on.
- **ALWAYS** turn off slicer, return auto engage lever to “Manual” position (automatic slicers only), and turn slice thickness dial completely clockwise after each use.
- **BEFORE CLEANING, SHARPENING, SERVICING OR REMOVING ANY PARTS**, always turn slicer off, turn slice thickness dial clockwise to closed position, remove food chute, and unplug power cord.
- **BE ALERT** that the food chute moves back and forth during automatic operation and can move in either direction on start up.

OPTIONAL ACCESSORIES

VEGETABLE HOPPER

This tubular chute temporarily converts the slicer into an efficient, heavy-duty meat, fruit and vegetable slicer. To use this chute, follow these procedures:



DO NOT put hands inside tubular chute during slicer operation.

1. Turn slicer off.
2. Close slicer table.
3. Remove food chute by loosening food chute release knob that fastens food chute to chute arm. Slide food chute off the chute arm.
4. Remove round end weight from tubular chute. Place chute in position on the chute arm. Tighten chute knob securely to prevent any “play” between tubular chute and the chute arm.
5. Fill tubular chute with desired product. Place round end weight in tubular chute.
6. Select desired setting with slice thickness dial.
7. Turn slicer on. Begin manual or automatic slicing. Follow operating instructions on pages 9 through 12.
8. Clean tubular chute and end weight with a mild detergent and a warm water solution.

SLICER FENCES

Slicer fences provide extra support to some types of food products during slicing. Two types are available: a low fence for slicing rectangular meats and cheeses, and a high fence for slicing large round objects. To use the slicer fences, follow these procedures:

1. Be sure food chute end weight is in stored position behind food chute.
2. Place fence in desired position on the food chute.
3. Tighten fence thumb screw to secure fence to food chute.
4. Two or more fences may be used for quantity slicing.
5. Load food product.
6. Select desired setting with slice thickness dial.
7. Turn slicer on. Begin manual or automatic slicing. Follow operating instructions on pages 9 through 12.
8. Clean slicer fences with a mild detergent and warm water solution.

OPTIMAL SLICING PERFORMANCE

TO OBTAIN THE MAXIMUM PERFORMANCE AND YIELD FROM YOUR GLOBE SLICER:

1. Read this entire manual before touching slicer and strictly follow all instructions and precautions. **THERE IS NO SUBSTITUTE FOR SAFETY!**
2. Lubricate the slicer per the instructions on pages 18 and 19.
3. Maintain a sharp knife and replace as necessary. Sharpen frequently for short durations (10-15 seconds). Globe recommends replacing the knife at approximately 11" diameter. Never attempt to replace the knife yourself. Contact an authorized Globe service company to replace the knife.
4. Clean knife prior to sharpening slicer per the instructions on pages 13 and 14.
5. As the knife is sharpened and the diameter is reduced, it will be necessary to have:
 - a. The table adjusted inward toward the knife in order to maintain a consistent 1/32" clearance between the table and knife.
 - b. The sharpener assembly adjusted lower to maintain proper alignment with the knife.

**We recommend an authorized Globe service company
perform all adjustments and preventive maintenance
(See front cover for service contact information).**

**By adequately maintaining your slicer, it will provide years of dependable
service. The only way to damage a Globe slicer is by neglect.**

SERVICE AND TROUBLESHOOTING GUIDE

SYMPTOM	CAUSE	SOLUTION
Slicer will not start	Slicer not plugged in Breaker at panel tripped	Plug in slicer Reset breaker at power box
Power indicator light flashing (model 4600)	Knife cover removed or not properly installed or food chute not in home position	Install knife cover or pull food chute all the way forward
Chute speed light flashing a 1	Auto engage lever in automatic position	Move auto engage lever to manual position and restart slicer
Chute speed light flashing a 2	Knife cover off	Install knife cover
Chute speed light flashing a 4	Food chute not in home position	Pull chute all the way forward and restart the slicer
Ragged cuts-poor yield	Dull knife Chipped knife Knife-slicer table gap too wide Knife too small, 11" or less	Sharpen knife-make sure knife and stones are clean Sharpen or have new knife installed Call for service to adjust slicer table Have new knife installed
Metal rubbing knife	Knife cover Food chute End weight Slicer table	Make sure knife cover is securely installed Tighten or adjust food chute Have defective end weight replaced Call for service to adjust slicer table
Hard to push food chute	No lubrication	Lubricate slide rods thoroughly with Globe oil. No vegetable oil!
Hard to sharpen	Stones dirty, wet or clogged with grease Knife dirty Worn stones Stones not properly aligned	Clean stones with soapy water and brush. Dry stones afterwards. Clean top and bottom of knife Have stones replaced Have sharpener adjusted

LIMITED WARRANTY

Globe Food Equipment Company (“GFE”) warrants to the original purchaser of new equipment that said equipment, when installed in accordance with our instructions within North America and subjected to normal use, is free from defects in material or workmanship for a period of 2 years on parts (excludes wear/expendable parts). The labor warranty is 1 year on labor from original installation, or 18 months from actual shipment date, whichever date occurs first. The motor pinion gear and knife drive gear have a 15 year limited warranty.

THIS WARRANTY IS IN LIEU OF ALL OTHER WARRANTIES, WHETHER EXPRESS OR IMPLIED. GFE EXPRESSLY DISCLAIMS ANY IMPLIED WARRANTY OF MERCHANTABILITY OR EXPRESS OR IMPLIED WARRANTY OF FITNESS FOR A PARTICULAR PURPOSE.

GFE’S OBLIGATION AND LIABILITY UNDER THIS WARRANTY IS EXPRESSLY LIMITED TO REPAIRING AND REPLACING EQUIPMENT WHICH PROVES TO BE DEFECTIVE IN MATERIAL OR WORKMANSHIP WITHIN THE APPLICABLE WARRANTY PERIOD. All repairs pursuant to this Warranty will be performed by an Authorized Designated GFE Service Location during normal working hours. IN NO EVENT SHALL GFE BE LIABLE FOR INCIDENTAL OR CONSEQUENTIAL DAMAGES TO BUYER OR ANY THIRD PARTY, INCLUDING, WITHOUT LIMITATION, LOSS OF PROPERTY, PERSONAL INJURY, LOSS OF BUSINESS OR PROFITS OR OTHER ECONOMIC LOSSES, OR STATUTORY OR EXEMPLARY DAMAGES, WHETHER IN NEGLIGENCE, WARRANTY, STRICT LIABILITY, OR OTHERWISE.

This Warranty is given only to the first purchaser from a retail dealer. No warranty is given to subsequent transferees.

This Warranty does not cover product failures caused by: failure to maintain, neglect, abuse, damage due to excess water, fire, normal wear, improper set up and use. Periodic maintenance including lubrication and sharpening are not covered.

This Warranty is not in force until such time as a properly completed and signed Installation/Warranty Registration has been received by GFE within 30 days from the date of installation.

THE FOREGOING WARRANTY PROVISIONS ARE A COMPLETE AND EXCLUSIVE STATEMENT BETWEEN THE BUYER AND SELLER. GFE NEITHER ASSUMES NOR AUTHORIZES ANY PERSONS TO ASSUME FOR IT ANY OTHER OBLIGATION OR LIABILITY IN CONNECTION WITH SAID EQUIPMENT.

Example of items not covered under warranty, but not limited to just these items:

1. Acts of God, fire, water damage, burglary, accident, theft.
2. Freight damage.
3. Improper installation or alteration of equipment.
4. Use of generic or after market parts.
5. Repairs made by anyone other than a GFE designated servicer.
6. Lubrication.
7. Expendable wear parts, knife, stones, rubber boots, blown fuses, lamps.
8. Cleaning of equipment.
9. Misuse or abuse.